

Xstage⁴

Solid Ground... Raised

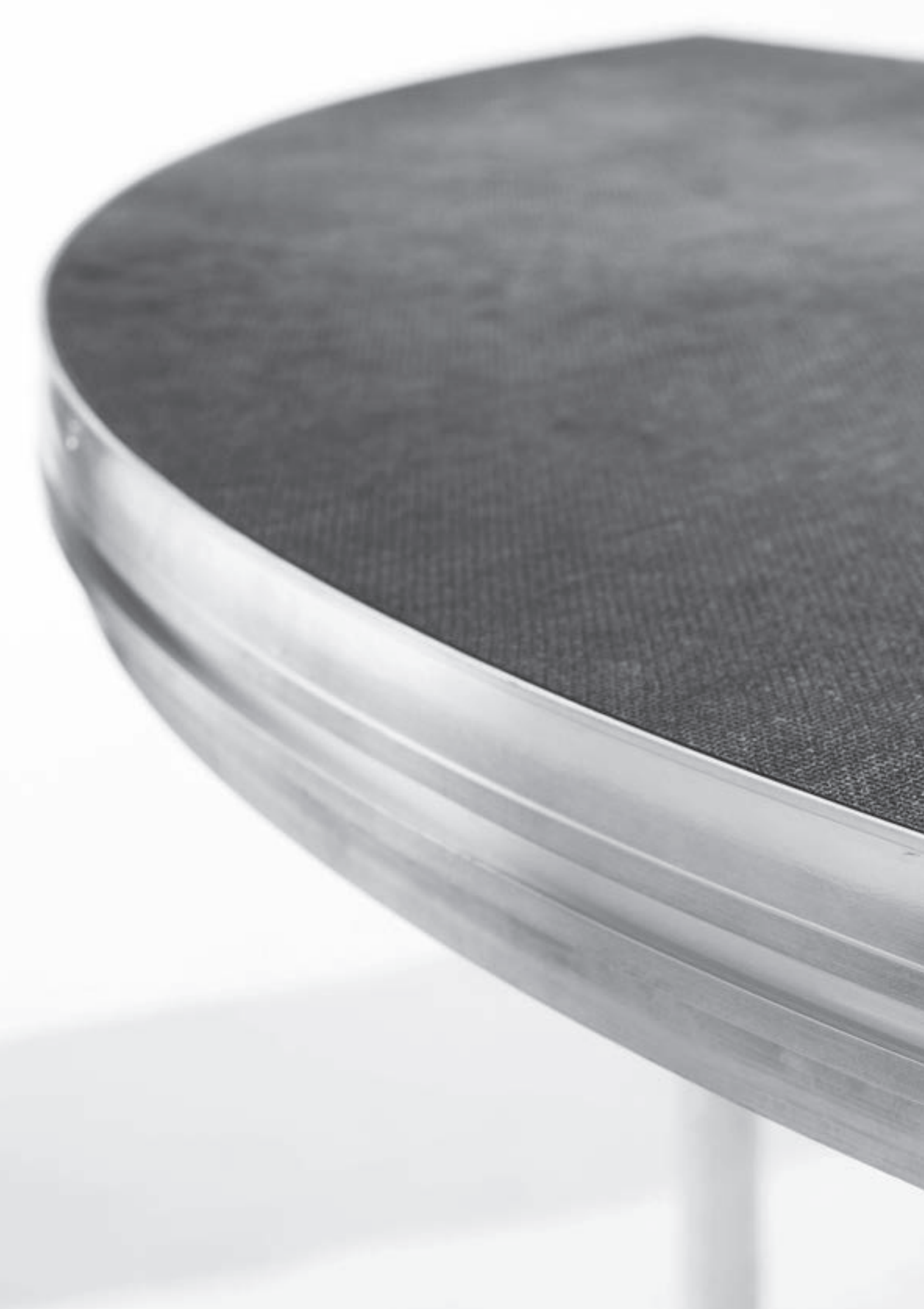

Product Catalogue



Decks

Xstage S10 / Xstage S9 / Xstage S8 / Xstage S1

6–21

Legs

Fixed / Adjustable / Telescopic / Screwjack
/ Leg connectors

20–21

Handrails, Guard Rails

XS1/ XS8/ XS9/ XS10

22–25

Stairs

Adjustable / Modular

26–27

Accessories

Transport carts / Connectors

28–29

Xstage extended height system

Decks / Legs / Girders, Braces / Handrails, Guard Rails,
Stairs, Ramps / Accessories

32–39

Xstage S10

Xstage decks are built to withstand the rigors of touring and fulfil the demanding requirements of large to small events. They handle loads up to 750 kg/m² (in accordance with DIN 15921) and feature tough, non-slip surfaces that are the perfect choice for your indoor and outdoor events. All decks are TUV approved and feature low profile designs, so attention always remains on the performers.



Xstage S10

Standard Product



Universal leg
securing system



S10 connector for
securing decks together



Cross section
of profile

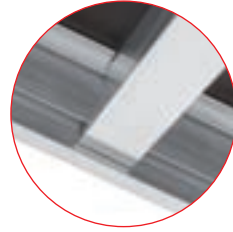

Central stabilizing
beam

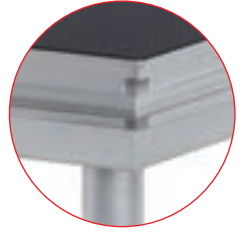

Deck corner and channel
for connectors



Deck Tops



Anti -slip,
hexagrip surface



Smooth, matt
black painted
surface

Xstage S10

Description

The new S10 deck from Xstage delivers top staging performance perfect for any size of live events. The new deck features a sleek custom extruded aluminium profile, which reduces overall weight without sacrificing load capacity. S10 includes a universal leg securing system to suit a wide range of leg options, a new indoor / outdoor, anti-slip hexagrip surface, and tough 12 mm birch plywood construction. The range delivers long-lasting durability and safety, and as with all Xstage decks, is designed to fully comply with DIN 15921 standards.

- Universal leg securing system
- Heavy-duty, 12mm birch plywood deck
- Waterproof and anti-slip hexagrip surface
- Complies with DIN 15921



Types of legs

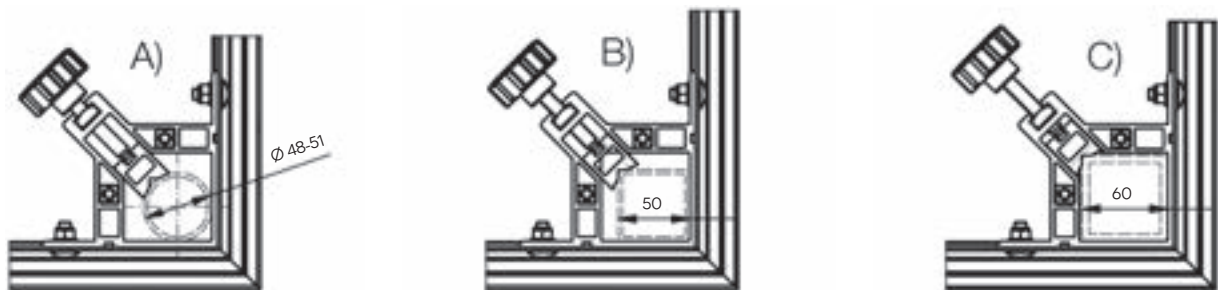

Compatible with round \varnothing 48-51 mm legs, as well as 40x40, 50x50, 60x60 mm square legs

Code	Deck size	Height options	Max. UDL	Top deck	Total weight	Storage height	Deck material
XS10DCK-PLH1 2x1m	2000x1000 mm (78.74 x 39.37")	200 - 1500 mm (787 - 59.06")	750 kg / m ² (153.60 lbs / ft ²)	12 mm (0.47")	33.00 kg (72.75 lbs)	90 mm (3.54")	Outdoor / Indoor birch plywood

Xstage S10

Stage Modules

S10 Deck 2x1m

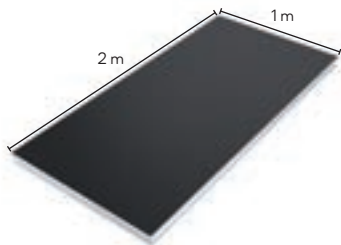

Code	Weight	Description
XS10DCK-PLH1 2x1m	33.00 kg (72.00 lbs)	Birch plywood 2x1 m (6.56x3.28 ft)

S10 Deck 2x0.5m

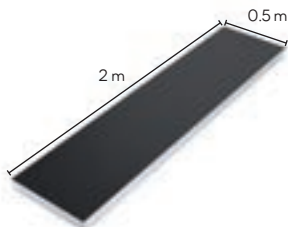

Code	Weight	Description
XS10DCK-PLH1 2x0.5m	19.50 kg (43.00 lbs)	Birch plywood 2x0.5 m (6.56 x1.64 ft)

S10 Deck 1x1m

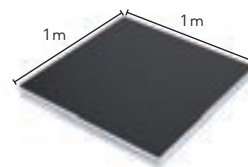

Code	Weight	Description
XS10DCK-PLH1 1x1m	19.50 kg (43.00 lbs)	Birch plywood 1x1 m (3.28x3.28 ft)

S10 Deck 1x0.5m

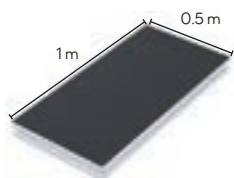

Code	Weight	Description
XS10DCK-PLH1 1x0.5m	12.00 kg (26.00 lbs)	Birch plywood hexagrip surface 1x0.5 m (3.28x1.64 ft)

S10 1m Quadrant

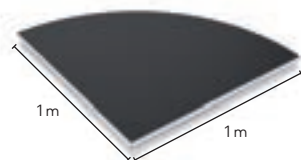

Code	Weight	Description
XS10DCK-PLH1 CRS001	15.50 kg (33.50 lbs)	Birch plywood 1 m quadrant (3.28 ft)

S10 Deck 1x1m Triangle

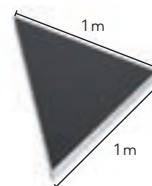

Code	Weight	Description
XS10DCK-PLH1 TRIO06	12.00 kg (26.00 lbs)	Birch plywood 1x1m (3.28x3.28 ft) triangle

S10 Deck 2x1m Trapezoid

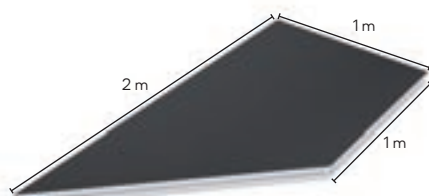

Code	Weight	Description
XS10DCK-PLH1 TRA010	24.50 kg (53.50 lbs)	Birch plywood 2x1 m (6.56x3.28 ft) trapezoid

Right hand version available ...|TRA011

S10 Deck 2x1m Triangle

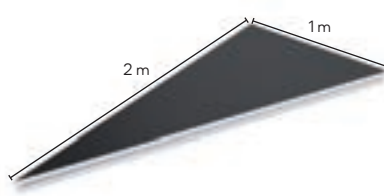

Code	Weight	Description
XS10DCK-PLH1 TRIO04	19.00 kg (41.50 lbs)	Birch plywood 2x1 m (6.56x3.28 ft) triangle

Right hand version available ...|TRIO05

Xstage S9

S9 decks are designed to satisfy the needs of large to small events, as well as the demands of extensive touring. Their popularity over the years, mainly in the UK market, have positioned them as the "go to" decks for event production professionals.



Xstage S9

Description



Leg pocket system



Deck top fixing



Cross section of profile



Deck connection point



Optional Rotalock for quick assembly



Deck Tops



Smooth, matt black painted surface

Xstage S9

Description

The S9 provides high loading capacity for a wide range of events, and comes standard as 8' x 4' (2.44 x 1.22 m) with a high-quality 18 mm poplar top (additional sizes of decks also available). Its lightweight aluminium deck features quick bolt together construction.

The S9 Rotalock system connects decks together with its integrated custom coffin lock system. One single turn of an Allen key will lock the decks into position which will rapidly speed up any stage build time.

- Designed to industry imperial dimensions
- Quick bolt together construction
- Lightweight aluminium deck



Optional Rotalock System available

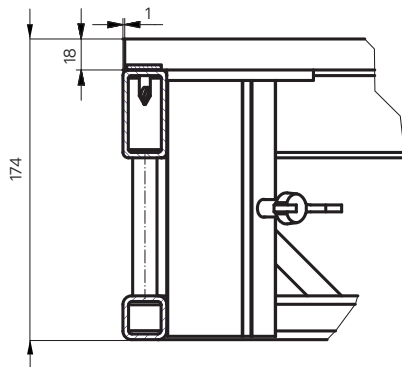
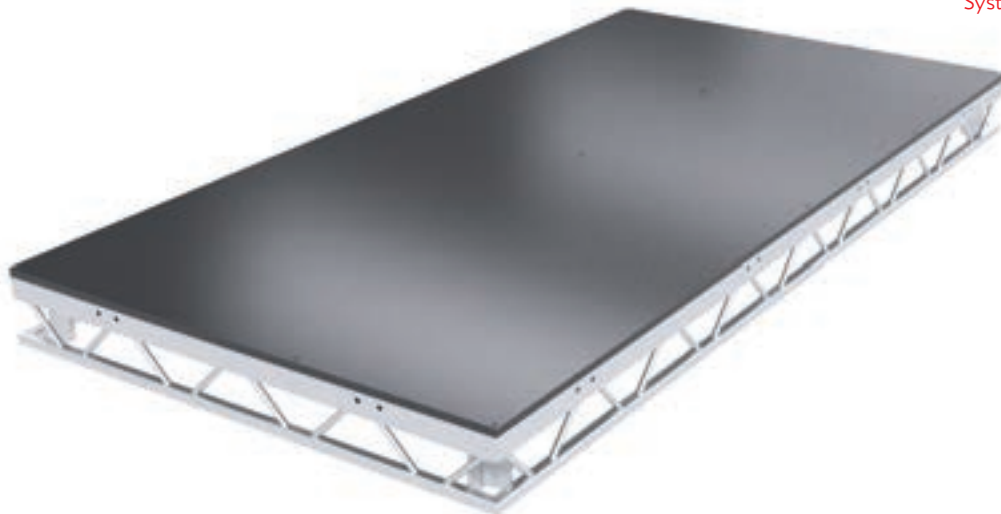

Cross section of profile

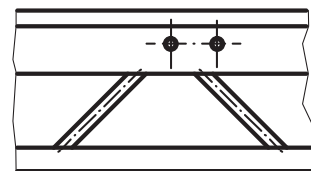

Deck connection point

Code	Deck size	Height options	Max. UDL	Deck top	Total weight	Storage height	Deck material
XS9DCK-PLB2 8'x4'	8'x4' (2.44x1.22 m)	7.87'-39.37" (200-1000 mm)	122.30 lbs / ft (600 kg / m ²)	0.71" (18 mm)	106 lbs (48 kg)	6.85" (174 mm)	Plywood

Xstage S9

Stage Modules

S9 Deck 8'x4'

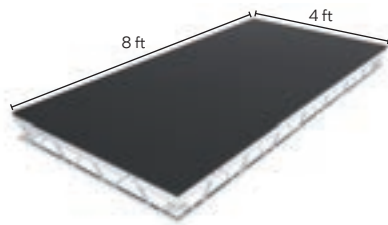

Code	Weight	Description
XS9DCK-PLB2 8'x4'	106.00 lbs (48.00 kg)	Plywood 8'x4' (2.44x1.22 m)
XS9DCK-PLB2R 8'x4'	109.00 lbs (49.50 kg)	Plywood 8'x4' (2.44x1.22 m)

S9 Deck 8'x2'

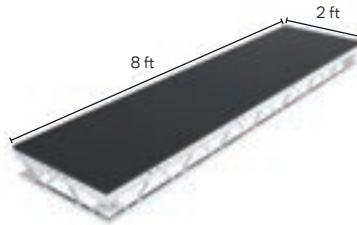

Code	Weight	Description
XS9DCK-PLB2 8'x2'	64.00 lbs (29.00 kg)	Plywood 8'x2' (2.44x0.60 m)
XS9DCK-PLB2R 8'x2'	65.50 lbs (30.00 kg)	Plywood 8'x2' (2.44x0.60 m)

S9 Deck 6'x4'

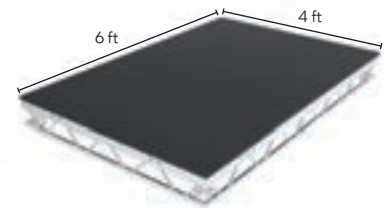

Code	Weight	Description
XS9DCK-PLB2 6'x4'	72.00 lbs (37.50 kg)	Plywood 6'x4' (1.83x1.22 m)
XS9DCK-PLB2R 6'x4'	85.00 lbs (38.50 kg)	Plywood 6'x4' (1.83x1.22 m)

S9 Deck 4'x2'

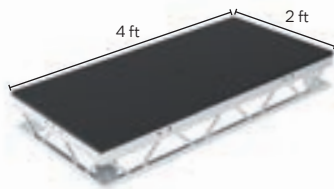

Code	Weight	Description
XS9DCK-PLB2 4'x2'	35.50 lbs (16.00 kg)	Plywood 4'x2' (1.22x0.60 m)
XS9DCK-PLB2R 4'x2'	37.50 lbs (17.00 kg)	Plywood 4'x2' (1.22x0.60 m)

S9 Deck 6'x2'

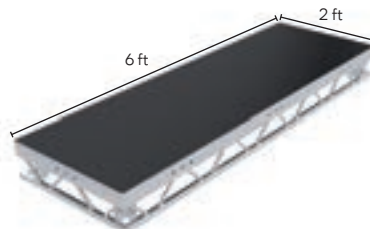

Code	Weight	Description
XS9DCK-PLB2 6'x2'	49.00 lbs (22.20 kg)	Plywood 6'x2' (1.83x0.60 m)
XS9DCK-PLB2R 6'x2'	51.00 lbs (23.20 kg)	Plywood 6'x2' (1.83x0.60 m)

S9 Deck 4'x4'

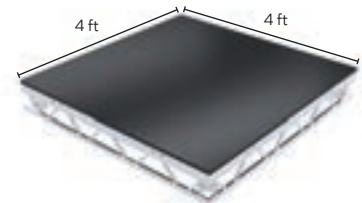

Code	Weight	Description
XS9DCK-PLB2 4'x4'	59.00 lbs (27.00 kg)	Plywood 4'x4' (1.22x1.22 m)
XS9DCK-PLB2R 4'x4'	61.00 lbs (27.50 kg)	Plywood 4'x4' (1.22x1.22 m)

S9 Deck 4'x4' Triangle

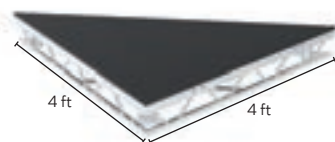

Code	Weight	Description
XS9DCK-PLB2 TRI4'x4'	40.50 lbs (18.50 kg)	Plywood 4'x4' (1.22x1.22 m)

S9 4' Quadrant



Code	Weight	Description
XS9DCK-PLB2 CRS4'x4'	52.00 lbs (23.50 kg)	Plywood 1/4 circle R = 4' ft (1.22 m)

S9 6' Quadrant



Code	Weight	Description
XS9DCK-PLB2 CRS6'x6'	99.20 lbs (45.00 kg)	Plywood 1/4 circle R = 6' ft (1.83 m)

Xstage S8

S8 is a high strength deck for small and mid-sized events. It features a quick release leg lock securing system and universal edge connections for fast & secure assembly. Its bottom channel also allows for the unique and secure attachment of the deck to truss structures.



Xstage S8

Standard Product

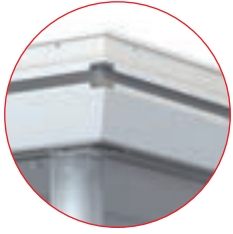

Deck corner and channel for connectors

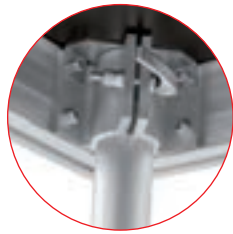

Leg pocket with quick release lever

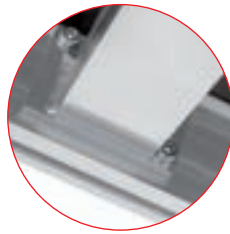

Central stabilizing beam



Screw fixings for top deck

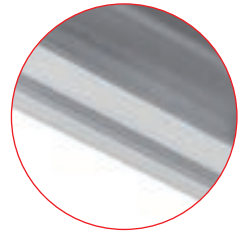

Lower profile attachment channel



Deck Tops



XS8 Plywood



XS8 Composite

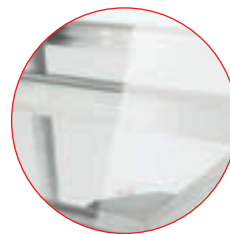

XS8 Plexiglass



Anti-slip, hexagrip top surface

Xstage S8

Description

A low profile design ensures attention remains on performers; while its loading capacity of up to 750 kg/m² (in accordance with DIN 15921) provides the support you require. The tough, anti-slip surface found on the S8 series ensures safety for performers during both indoor and outdoor events. Decks can be secured to truss structures via special fixings attached to the underside channel profile.

- Quick release leg securing system
- Heavy-duty, 15 mm birch plywood deck
- Waterproof and anti-slip deck surface
- Complies with DIN 15921

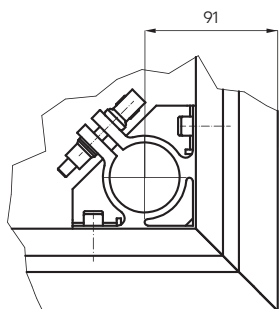

Leg pocket

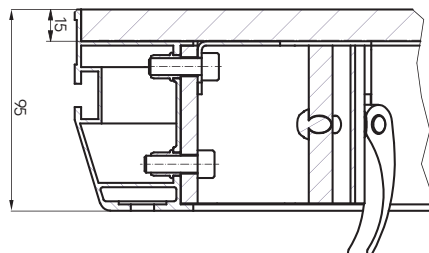

Quick release lever for securing legs to deck

Code	Deck size	Height options	Max. UDL*	Top deck	Total weight	Storage height	Deck material
XSBDCK-PLA1 2x1m	2000x1000 mm (78.74 x 39.37")	200 - 1500 mm (7.87 - 59.06")	750 kg/m ² (153.60 lbs / ft ²)	15 mm (0.59")	38.00 kg (84 lbs)	95 mm (3.74")	Outdoor plywood
XSBDCK-CMA2 2x1m	2000x1000 mm (78.74 x 39.37")	200 - 1500 mm (7.87 - 59.06")	750 kg/m ² (153.60 lbs / ft ²)	15 mm (0.59")	28.00 kg (62 lbs)	95 mm (3.74")	Composite
XSBDCK-PXB4 2x1m	2000x1000 mm (78.74 x 39.37")	200 - 1500 mm (7.87 - 59.06")	750 kg/m ² (153.60 lbs / ft ²)	15 mm (0.59")	58.00 kg (128 lbs)	95 mm (3.74")	Plexiglass

Xstage S8

Stage Modules

S8 Deck 2x1m

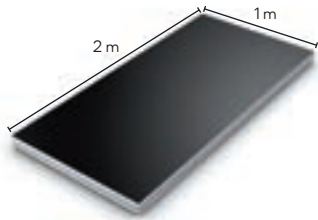

Code	Weight	Description
XS8DCK-PLA1 2x1m	38.00 kg (84.00 lbs)	Plywood 2x1 m (6.56x3.28 ft)
XS8DCK-CMA2 2x1m	28.00 kg (62.00 lbs)	Composite 2x1 m (6.56x3.28 ft)
XS8DCK-PXB4 2x1m	58.00 kg (128.00 lbs)	Plexi 2x1 m (6.56x3.28 ft)

S8 Deck 2x0.5m

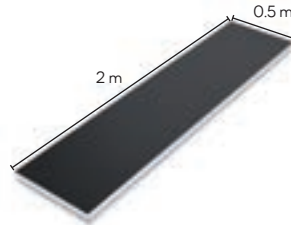

Code	Weight	Description
XS8DCK-PLA1 2x0.5m	26.00 kg (57.50 lbs)	Plywood 2x0.5 m (6.56 x1.64 ft)
XS8DCK-CMA2 2x0.5m	19.00 kg (42.00 lbs)	Composite 2x0.5 m (6.56 x1.64 ft)
XS8DCK-PXB4 2x0.5m	50.00 kg (110.50 lbs)	Plexi 2x0.5 m (6.56 x1.64 ft)

S8 Deck 1x1m

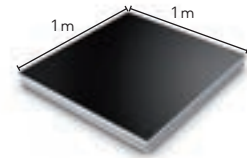

Code	Weight	Description
XS8DCK-PLA1 1x1m	26.00 kg (57.50 lbs)	Plywood 1x1 m (3.28x3.28 ft)
XS8DCK-CMA2 1x1m	19.00 kg (42.00 lbs)	Composite 1x1 m (3.28x3.28 ft)
XS8DCK-PXB4 1x1m	50.00 kg (110.50 lbs)	Plexi 1x1 m (3.28x3.28 ft)

S8 Deck 1x0.5m

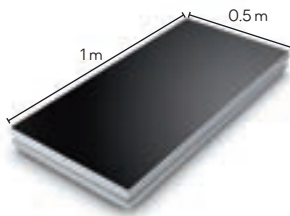

Code	Weight	Description
XS8DCK-PLA1 1x0.5m	20.00 kg (44.00 lbs)	Plywood 1x0.5 m (3.28x1.64 ft)
XS8DCK-CMA2 1x0.5m	17.00 kg (37.50 lbs)	Composite 1x0.5 m (3.28x1.64 ft)
XS8DCK-PXB4 1x0.5m	30.00 kg (66.00 lbs)	Plexi 1x0.5 m (3.28x1.64 ft)

S8 1m Quadrant

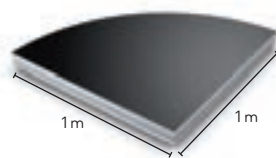

Code	Weight	Description
XS8DCK-PLA1 CRS001	26.00 kg (57.50 lbs)	Plywood 1m (3.28 ft) quadrant
XS8DCK-CMA2 CRS001	18.00 kg (42.00 lbs)	Composite 1m (3.28 ft) quadrant
XS8DCK-PXB4 CRS001	50.00 kg (110.00 lbs)	Plexi 1m (3.28 ft) quadrant

S8 Deck 1x1m Triangle

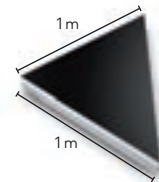

Code	Weight	Description
XS8DCK-PLA1 TRIO06	26.00 kg (57.50 lbs)	Plywood 1x1 m (3.28x3.28 ft) triangle
XS8DCK-CMA2 TRIO06	19.00 kg (42.00 lbs)	Composite 1x1 m (3.28x3.28 ft) triangle
XS8DCK-PXB4 TRIO06	50.00 kg (110.00 lbs)	Plexi 1x1 m (3.28x3.28 ft) triangle

S8 Deck 2x1m Trapezoid

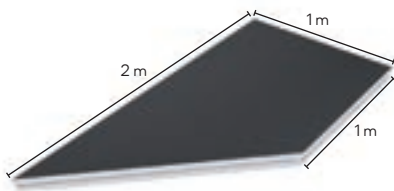

Code	Weight	Description
XS8DCK-PLA1 TRA010	25.00 kg (55.00 lbs)	Plywood 2x1 m (6.56x3.28 ft) trapezoid
XS8DCK-CMA2 TRA010	18.00 kg (40.00 lbs)	Composite 2x1 m (6.56x3.28 ft) trapezoid
XS8DCK-PXB4 TRA010	38.00 kg (84.00 lbs)	Plexi 2x1 m (6.56x3.28 ft) trapezoid

Right hand version available ...|TRA011

S8 Deck 2x1m Triangle

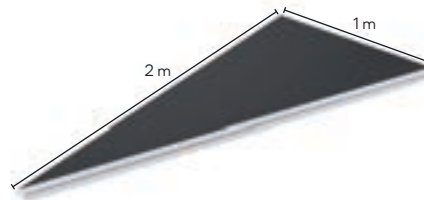

Code	Weight	Description
XS8DCK-PLA1 TRIO04	28.00 kg (55.00 lbs)	Plywood 2x1 m (6.56x3.28 ft) triangle
XS8DCK-CMA2 TRIO04	18.00 kg (40.00 lbs)	Composite 2x1 m (6.56x3.28 ft) triangle
XS8DCK-PXB4 TRIO04	38.00 kg (84.00 lbs)	Plexi 2x1 m (6.56x3.28 ft) triangle

Right hand version available ...|TRIO05

Xstage S1

The adjustable scissor leg S1 deck is ideal for semi-permanent installations and small to mid-sized live events. The scissor leg feature allows you to quickly and easily customize decks to the height you require, as well as give you the creative flexibility to create stages with different levels for adding a further dynamic edge to live performances.



Xstage S1

Standard Product



Cable brake system



Locking pin



Scissor leg attachment point



Scissor leg foot



Scissor leg reinforcement bar



Deck Tops



Outdoor plywood



Indoor plywood



New anti-slip, hexagrip top surface

Xstage S1

Description

The S1 is an ideal solution for semi-permanent installations. Featuring adjustable scissor legs, with an integrated cable brake system, it conveniently adapts to a wide range of heights. Storage and transport space requirements are greatly reduced thanks to its folding feature. Its low profile design keeps attention on your performers, while its load capacity of up to 750 kg/m² (in accordance with DIN 15921) supports the weight your large to small events require. Due to its tough, non-slip surface, safety is ensured for performers during both indoor and outdoor events.

- Low profile design with loading up to 750kg/m²
- Indoor and outdoor deck finish options available
- Adjustable scissor leg stage deck

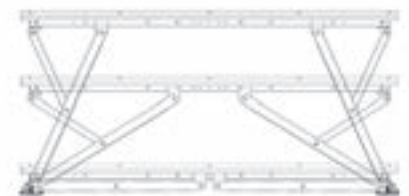

Flexible scissor leg feature allows for quick and easy height adjustment from 400 mm - 1000 mm

Code	Deck size	Height options	Max. UDL	Top deck	Total weight	Storage height	Deck material
XS1DCK-LTB3 2x1m	2000x1000 mm (78.74 x 39.37")	400 - 600 - 800 - 1000 mm (15.75 - 23.62 - 31.50 - 39.37")	750 kg / m ² (153.60 lbs / ft ²)	22 mm (0.87")	63.00 kg (139 lbs)	200 mm (7.87")	Indoor plywood
XS1DCK-PLA1 2X1m	2000x1000 mm (78.74 x 39.37")	400 - 600 - 800 - 1000 mm (15.75 - 23.62 - 31.50 - 39.37")	750 kg / m ² (153.60 lbs / ft ²)	22 mm (0.87")	66.30 kg (146 lbs)	200 mm (7.87")	Outdoor plywood

Stage Modules

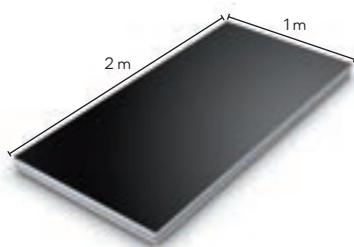

Code	Weight	Description
XS1DCK-LTB3 2x1m	63.00 kg (139.00 lbs)	Indoor plywood 2x1 m (6.56x3.28 ft)
XS1DCK-PLA1 2X1m	63.00 kg (139.00 lbs)	Outdoor plywood 2x1 m (6.56x3.28 ft)



Legs

Achieve a wide range of heights with Xstage aluminium legs, which come in fixed length, adjustable and telescopic versions. Fixed length legs are offered in 200–1000 mm lengths. Adjustable legs feature a range of 200–1500 mm. Telescopic legs are adjustable from 500–1500 mm. All legs feature strong and durable 48 x 3 mm aluminium tubes for increased strength and durability.



Legs

All Xstage legs are made from high quality aluminium to ensure strength and durability for the long term. And with three different versions available, you're able to choose the leg that best suits your needs.

Leg Types

Fixed



Aluminium tube leg with plastic end cap. Compatible with all Xstage decks.

Code	Description	Height options
XSULEG-FXR1	48 mm (1.89') diameter 3 mm (0.12') thick tube	200-1000 mm (0.65-3.28 ft) heights available

Adjustable



Aluminium tube leg with adjustable foot (50 mm adjustment range). Compatible with all Xstage decks.

Code	Description	Height options
XSULEG-ADR1	48 mm (1.89') diameter 3 mm (0.12') thick tube	200-1000 mm (0.65-3.28 ft) heights available

Telescopic



Telescopic aluminium tube leg with adjustable foot. Compatible with all Xstage decks.

Code	Description	Height options
XSULEG-TLR2	48 mm (1.89') diameter Reinforced profile inside 3mm (0.12') thick tube	(500-700 mm) (1.64-2.29 ft) (700-1000 mm) (2.29-3.28 ft) (1000-1500 mm) (3.28-4.92 ft) heights available

Leg Connectors

Screwjack



Adjustable screwjack

Code	Description	Height options
XSULEG-SJ1	38 mm (1.5 ft) diameter 7 mm (0.3 ft) thick tube	2 - 17.5 ft (50-440 mm) heights available

S8 Connector for 2 Legs



Connector for securing two S8 deck legs together.

Code	Weight
XS8CON-2LEG1	1.00 kg (2.20 lbs)

S8 Connector for 4 legs



Connector for securing four S8 deck legs together.

Code	Weight
XS8CON-4LEG1	2.30 kg (5.00 lbs)

S10 Connector for 2 Legs



Connector for securing two S10 deck legs together.

Code	Weight
XS10CON-2LEG1	1.00 kg (2.20 lbs)

S10 Connector for 4 Legs



Connector for securing four S10 deck legs together.

Code	Weight
XS10CON-4LEG1	2.30 kg (5.00 lbs)

S9 4 into 1 Leg Saver



4 into 1 leg saver

Code	Weight
XS9LEG-4LEGA1	1.80 kg (4.00 lbs)

Handrails, Guard Rails

Increase the safety and convenience of your Xstage decks with high quality handrails, guard rails and chairstop. All are made from aluminium, which provides high strength and durability.



Handrails, Guard Rails

Handrails, Guard Rails increase the safety of your decks by attaching firmly and securely to the deck's profile. They can be installed in a series on any side or position of your stage.

S10, S8, S1

Handrail 1000



High quality, 1000 mm aluminium handrail for the safety and convenience of your S10 ,S8 and S1 stages.

Code	Weight	Description
XS10RAI-HR1 1000	5.00 kg (10.00 lbs)	1000 mm (39.37") handrail for S10
XS8RAI-HR1 1000	5.00 kg (10.00 lbs)	1000 mm (39.37") handrail for S8
XS1RAI-HR1 1000	5.00 kg (10.00 lbs)	1000 mm (39.37") handrail for S1

Handrail 2000



High quality, 2000 mm aluminium handrail for the safety and convenience of your S10 ,S8 and S1 stages.

Code	Weight	Description
XS10RAI-HR1 2000	6.50 kg (14.50 lbs)	2000 mm (78.74") handrail for S10
XS8RAI-HR1 2000	6.50 kg (14.50 lbs)	2000 mm (78.74") handrail for S8
XS1RAI-HR1 2000	6.50 kg (14.50 lbs)	2000 mm (78.74") handrail for S1

Guard Rail 1000



High quality, 1000 mm heavy-duty aluminium guard rail for the safety and convenience of your S10 ,S8 stages.

Code	Weight	Description
XS10RAI-GR1 1000	7.00 kg (15.50 lbs)	1000 mm (39.37") guard rail for S10
XS8RAI-GR1 1000	7.00 kg (15.50 lbs)	1000 mm (39.37") guard rail for S8

Guard Rail 2000



High quality, 2000 mm heavy-duty aluminium guard rail for the safety and convenience of your S10, S8 stages.

Code	Weight	Description
XS10RAI-GR1 2000	9.50 kg (15.50 lbs)	2000 mm (78.74") guard rails for S10
XS8RAI-GR1 2000	9.50 kg (15.50 lbs)	2000 mm (78.74") guard rails for S8

Handrail / Guard Rail Connector



Handrail / Guard Rail straight connectors that allow for the flexible connection of handrails / guard rails together.

Code	Weight	Description
XS10CON-2LEG1	0.25 kg (0.50 lbs)	Straight connector
XS10CON-RC1	0.25 kg (0.50 lbs)	Corner connector

Handrail / Guard Rail Adaptor



Adaptor that allows for the connection of Handrails and Guard Rails to S10 decks

Code	Weight
XS10RAI-A1	0.60 kg (0.25 lbs)

Handrail / Guard Rail Straight Connector



Handrail / Guard Rail straight connector that allows for the flexible connection of handrails / guard rails on S1 and S8 decks.

Series	Weight
XS8CON-RS1	0.25 kg (0.50 lbs)
XS1CON-RS1	0.25 kg (0.50 lbs)

Handrail / Guard Rail Corner Connector



Handrail / Guard Rail corner connector that allows for the flexible connection of handrails / guard rails to S1 and S8 decks.

Series	Weight
XS8CON-RC1	0.25 kg (0.50 lbs)
XS1CON-RC1	0.25 kg (0.50 lbs)

Handrails and Guard Rails

S9 handrails and guard rails available in imperial sizes for the UK market. There are two versions for each length – standard (for general use) and heavy-duty (for public access use).

S9

Handrail 2'



Code	Weight	Description
XS9RAI-HR1 2'	8.00 lbs (3.70 kg)	2' (609.60 mm) handrail for S9

Supplied with connection bolts

Handrail 4'



Code	Weight	Description
XS9RAI-HR1 4'	14.50 lbs (6.50 kg)	4' (1219.20 mm) handrail for S9

Supplied with connection bolts

Handrail 6'



Code	Weight	Description
XS9RAI-HR1 6'	17.00 lbs (7.50 kg)	6' (1828.80 mm) handrail for S9

Supplied with connection bolts

Handrail 8'



Code	Weight	Description
XS9RAI-HR1 8'	20.00 lbs (9.00 kg)	8' (2438.40 mm) handrail for S9

Supplied with connection bolts

Guard Rail 2'



Code	Weight	Description
XS9RAI-GR1 2'	18.00 lbs (8.00 kg)	2' (609.60 mm) guard rail for S9

Supplied with connection bolts

Guard Rail 4'



Code	Weight	Description
XS9RAI-GR1 4'	31.00 lbs (14.00 kg)	4' (1219.20 mm) guard rail for S9

Supplied with connection bolts

Guard Rail 6'



Code	Weight	Description
XS9RAI-GR1 6'	41.00 lbs (18.50 kg)	6' (1828.80 mm) guard rail for S9

Supplied with connection bolts

Guard Rail 8'



Code	Weight	Description
XS9RAI-GR1 8'	51.50 lbs (23.50 kg)	8' (2438.40 mm) guard rail for S9

Supplied with connection bolts



Stairs

Xstage stairs offer you a safe and convenient solution for accessing all Xstage decks and bringing up your equipment. The stairs are available in either modular steel and adjustable aluminium construction stair versions. Handrails are included with adjustable stairs and are available as an option for the modular version.



Stairs

We offer two high quality and durable stair options, our top-of-the-line aluminium adjustable stairs and entry-level steel modular stairs, so you can choose what best suits your needs. The adjustable design of our aluminium stairs for small to large events provide you with flexible 600 mm - 1500 mm height adjustment for convenient access to elevated S1, S8, S9 and S10 stages. Our entry line of steel stairs for S1, S8 and S10 stages consist of modular steps that are purchased individually, according to the height you require - from 200 mm to 1400 mm.

Standard Line



Handrail to stair attachment point



Side view of top step



Stairs to deck attachment point



Step attachment point

Stair Types

Adjustable Stairs 600-1000mm



Adjustable stairs offer you a safe and convenient solution for accessing all S1, S8, S9 and S10 stages.

Adjustable Stairs 1000-1500mm



Modular Stairs 1000mm



Steel stairs offer you a safe and convenient solution for accessing all S1, S8 and S10 Xstage stages.

Code	Weight	Description
XSUSTA-AD1 600-1000	35.00 kg (77.00 lbs)	Adjustable 600 - 1000 mm stairs (23.62"-39.37"), including handrails
XSUSTA-AD1 1000-1500	46.00 kg (101.50 lbs)	Adjustable 1000 - 1500 mm stairs (39.37"-59.06"), including handrails

Code	Weight	Description
XSUSTA-MS1 1000	42.00 kg (92.50 lbs)	Stairs up to 1000 mm (39.37") - metal profile with 200 mm wide wooden steps

Accessories

All Xstage accessories are manufactured to the highest quality for safe, reliable and durable operation. All accessories are made from high strength aluminium for extended durability.

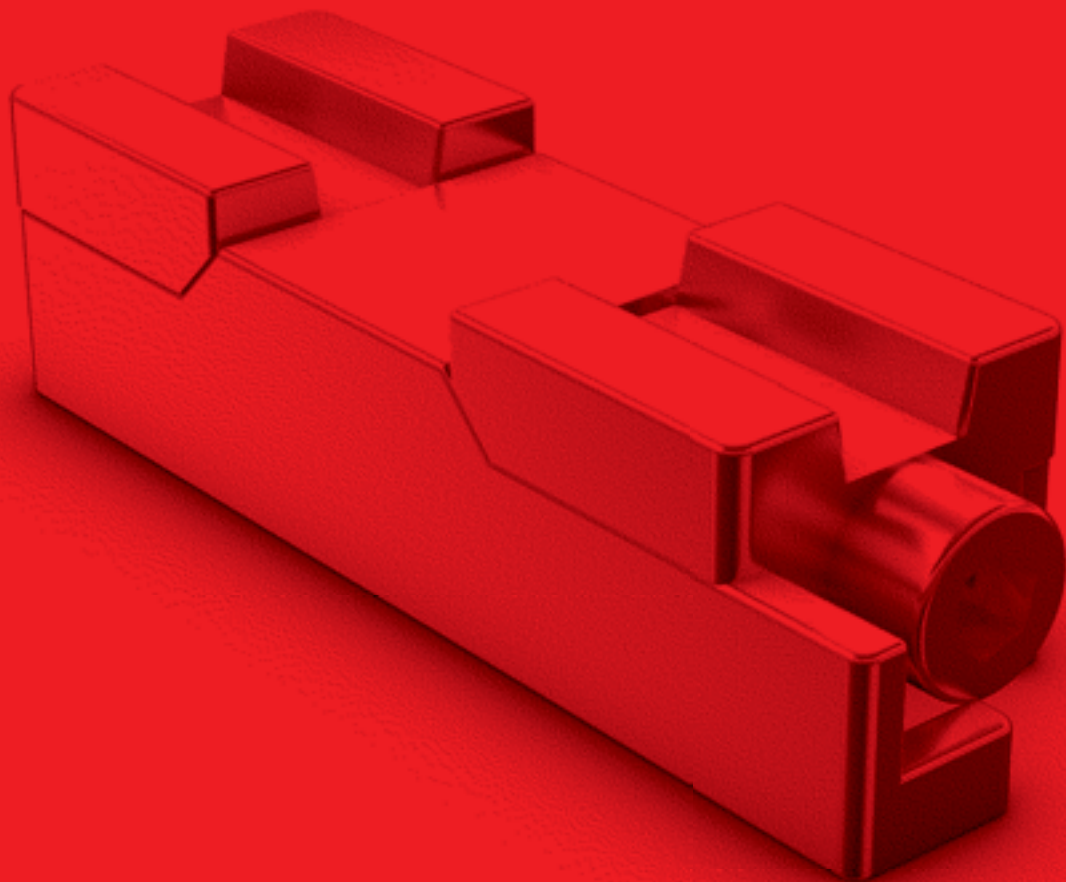

Connectors

Xstage connectors and leveler ensure the secure attachment of Xstage accessories to your Xstage decks. All connectors and leveler are made from the highest quality aluminium for superior strength and safety.

Types

S1 Connector



Code	Weight	Description
XSUCON-DTD1	0.06 kg (0.10 lbs)	Xstage connector with M5 allen bolt for connecting S1/S8 decks together

S10 Connector



Code	Weight	Description
XS10CON-DTD1	0.06 kg (0.10 lbs)	Connector with M5 allen bolt for connecting S10 decks together

S10 Low Profile Connector



Code	Weight	Description
XS10CON-LW1	0.30 kg (0.60 lbs)	Connector with spring loaded wingnut for connecting the lower profile edge of S10 decks together

S10 Universal Connector



Code	Weight	Description
XS10ACC-S1M10 10PCS	0.10kg (0.20 lbs)	Connector with M10 threaded bolt hole for the attachment of S10 accessories (kick boards, step units, etc.)

S10 Leveller



Code	Weight	Description
XS10ACC-LV1	0.02 kg (0.04 lbs)	Leveller with M10 threaded bolt hole for the horizontal levelling of S10 decks.

S9 Connecting Set



Code	Weight	Description
XS9CON-SET	0.02 kg (0.04 lbs)	Set of 2 bolts for connecting S9 decks together

Chairstop 1000



Chairstop provides an added measure of safety by providing a low profile barrier that guards against chairs and rolling equipment from falling off the deck.

Series	Weight	Description
XSUACC-CHS1 1000	1.00 kg (2.50 lbs)	1 m long Compatible with S1, S8 and S10 decks

XSSTONE-M10



Series	Weight	Description
XSUACC-S1M10	0.04 kg (0.09 lbs)	Stone M10 for S1 and S8

Transport cart

Our all-aluminium transport carts are designed to easily and conveniently transport Xstage decks during load in / load out and from warehouse to truck and back again. Their aluminium construction and intelligent design ensure extreme durability and long-term trouble free operation.

Cart Types

Vertical Transport Cart



Our all-aluminium transport carts are designed to easily and effectively carry Xstage decks standing up on their sides.

Code	Weight	Description
XSUCRT-V1	37.50 kg (81.50 lbs)	Holds up to 6 pcs. of S1 decks or 10 pieces of S8/S10 decks

Horizontal Transport Cart



Our all-aluminium transport carts are designed to easily and effectively carry Xstage decks laying on top of each other.

Series	Weight	Description
XSUCRT-H1	58.00 kg (128.00 lbs)	Holds up to 5 pcs. of S1/S8/S10 decks



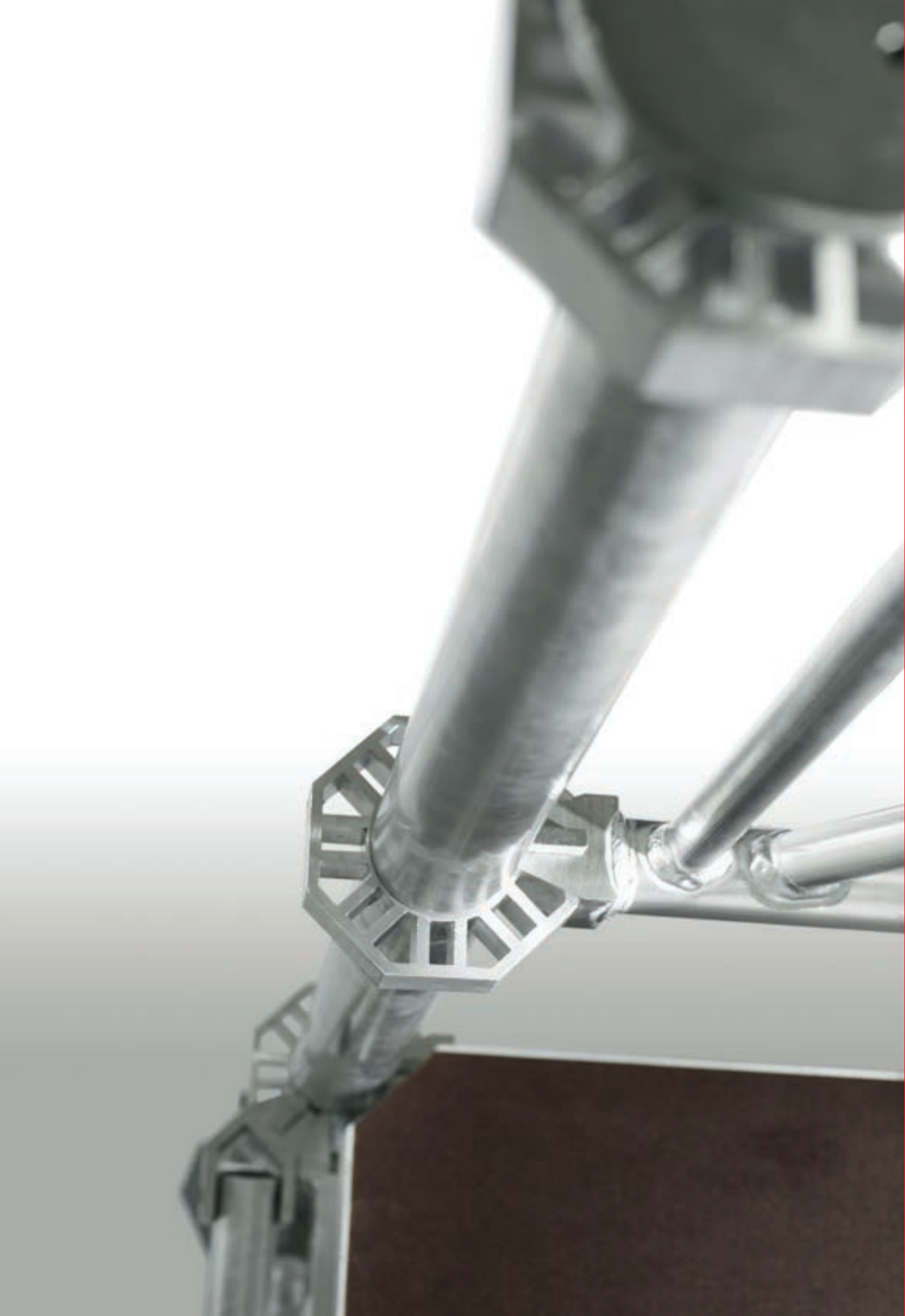

Xstage extended height system

The versatile node platform stage systems from Xstage deliver towering heights and multi-tier platforms using standard parts in the Xstage range. All systems feature tapered wedge brace connections for a rigid, tolerance-free structure. Indoor and outdoor surface finishes on the decks are available.



Xstage extended height system

With the Xstage system, you're provided with a versatile node platform stage with towering heights and multi-tier platforms using standard parts. Its tapered wedge brace connectors provide rigid, tolerance-free assembly. Indoor/Outdoor surface finishes available.



Deck Types

Plywood Deck



The XS4DCK-PLA1|2x1m 2X1M is a lightweight, but super strong, plywood platform stage system for your small to mid-sized live events.

Plexiglass Deck



The XS4DCK-PXB4|2x1m 2X1M is a high strength platform stage system with transparent plexiglass deck (also available in various colours) for your small to mid-sized live events.

Code	Deck size	Height options	Max. UDL	Top deck	Total weight	Storage height	Deck material
XS4DCK-PLA1 2x1m	2000x1000 mm (78.74 x 39.37")	1000 - 2500 mm (39.37 - 98.43')	750 kg / m ² (153.60 lbs / ft ²)	22 mm (0.87")	38.00 kg (84 lbs)	200 mm (7.87")	Outdoor plywood
XS4DCK-PXB4 2x1m	2000x1000 mm (78.74 x 39.37")	1000 - 2500 mm (39.37 - 98.43')	750 kg / m ² (153.60 lbs / ft ²)	22 mm (0.87")	58.00 kg (128 lbs)	200 mm (7.87")	Plexiglass

Xstage extended height system

Leg Types

S4 Leg

A safe and stable adjustable leg system for achieving heights from 1000 mm – 2500 mm with your Xstage platform stage system. One module is 500mm long. Weight: 2 kg.

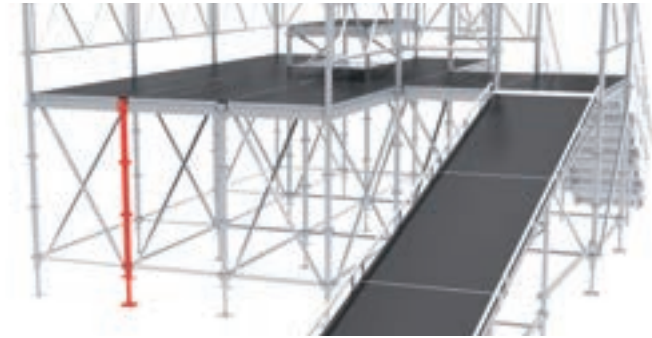
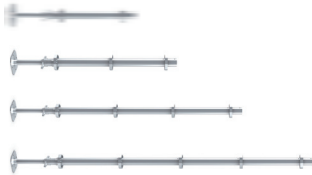

Code	Weight	Description
XS4LEG-B1 1000	5.00 kg (11.00 lbs)	60x5 mm (2.36" x 0.20")
XS4LEG-B1 1500	7.00 kg (15.00 lbs)	tube leg

Code	Weight	Description
XS4LEG-B1 2000	9.00 kg (19.50 lbs)	60x5 mm (2.36" x 0.20")
XS4LEG-B1 2500	10.50 kg (23.00 lbs)	tube leg

S4 Leg-GR

A safe and secure adjustable guard rail leg system for achieving heights from 2000 mm – 3500 mm on your Xstage platform stage system. Each module is 500 mm long. Weight: 2 kg.

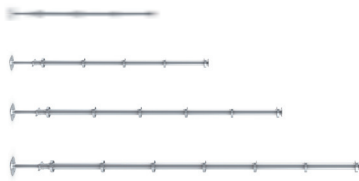

Code	Weight	Description
XS4LEG-GR1 2000	9.00 kg (20.00 lbs)	60x5 mm (2.36" x 0.20")
XS4LEG-GR1 2500	11.00 kg (24.00 lbs)	tube leg with guard rail cap

Code	Weight	Description
XS4LEG-GR1 3000	12.50 kg (28.00 lbs)	60x5 mm (2.36" x 0.20")
XS4LEG-GR1 3500	14.50 kg (32.00 lbs)	tube leg with guard rail cap

Screwjack

An adjustable foot attachment for the safe and secure levelling of your Xstage platform stage system. Adjustment range up to 400 mm. Weight: 1.6 kg.



Code	Weight	Description
XSULEG-SJ1	1.60 kg (3.50 lbs)	For stage levelling up to 400 mm (15.75") heights

Xstage extended height system

Girder and Brace Types

S4 Girder 1000

1000 mm heavy-duty horizontal girder for strengthening and supporting your Xstage platform stage system at height.



Code	Weight	Description
XS4GIR-H1 1000	1.40 kg (3.00 lbs)	S4 girder 1000 mm (39.37")



S4 Girder 2000

2000 mm heavy-duty horizontal girder for strengthening and supporting your Xstage platform stage system at height.



Code	Weight	Description
XS4GIR-H1 2000	3.00 kg (6.50 lbs)	S4 girder 2000 mm (78.74")



S4 Brace 1000

1000 mm heavy-duty horizontal brace for strengthening and supporting your Xstage platform stage system at height.



Code	Weight	Description	
XS4BRA-H1 1000	1.00 kg (2.20 lbs)	S4 brace 1000 mm (39.37") straight	40x2 tube (1.57" x 0.08")



S4 Brace 2000

2000 mm heavy-duty horizontal brace for strengthening and supporting your Xstage platform stage system at height.



Code	Weight	Description
XS4BRA-H1 2000	1.60 kg (3.50 lbs)	S4 brace 2000 mm (78.74") straight



Xstage extended height system

S4 Diagonal Brace

Heavy-duty diagonal brace for strengthening and supporting your Xstage platform stage system at height.

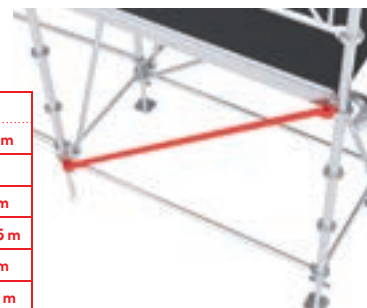

Code	Weight	sloping brace; 40x2mm (1.57"x 0.08") tube
XS4BRA-A1 1000x500	1.25 kg (2.80 lbs)	S4 diagonal support brace 1000 for 1x0.5 m
XS4BRA-A1 1000x1000	1.50 kg (3.20 lbs)	S4 diagonal support brace 1000 for 1x1 m
XS4BRA-A1 1000x1500	1.70 kg (3.75 lbs)	S4 diagonal support brace 1000 for 1x1.5 m
XS4BRA-A1 2000x500	1.90 kg (4.10 lbs)	S4 diagonal support brace 2000 for 2x0.5 m
XS4BRA-A1 2000x1000	2.00 kg (4.40 lbs)	S4 diagonal support brace 2000 for 2x1 m
XS4BRA-A1 2000x1500	2.20 kg (4.75 lbs)	S4 diagonal support brace 2000 for 2x1.5 m

Stairs, Handrails and Ramps

S4 Stairs

Enjoy convenient access to your elevated Xstage platform stage system with our XS4 stairs, which come in top, middle and bottom modules for fast and easy assembly.

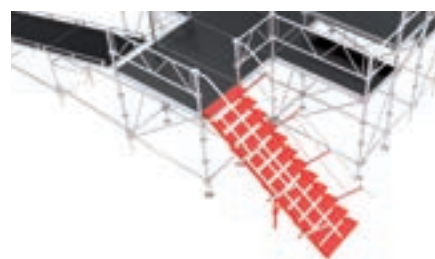

Code	Weight	Description
XS4STA-T1	21.00 kg (46.00 lbs)	S4 stairs-top
XS4STA-M1	21.00 kg (46.00 lbs)	S4 stairs-middle
XS4STA-B1	21.00 kg (46.00 lbs)	S4 stairs-bottom

S4 Handrail for Stairs

Enjoy increased safety on your elevated Xstage platform stage system with our XS4 handrail for stairs, which come in top, middle and bottom modules for fast and easy assembly. 40mm diameter, 2 mm thick tubes.

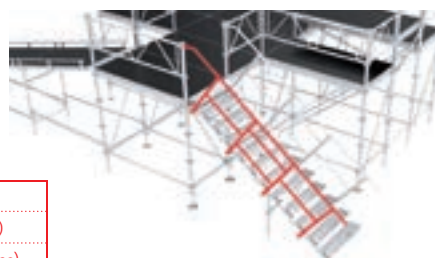

Code	Weight	Description
XS4RAI-ST1T	7.50 kg (16.00 lbs)	S4 handrail-top (one piece)
XS4RAI-ST1M	6.00 kg (11.00 lbs)	S4 handrail-middle (one piece)
XS4RAI-ST1B	4.50 kg (9.50 lbs)	S4 handrail-bottom (one piece)

S4 Handrail 1000

Increase the safety and security of your Xstage platform stage system with our 1000 mm handrail. 40 mm diameter, 2 mm thick tubes.



Code	Weight	Description
XS4RAI-GR 1000	3.60 kg (8.00 lbs)	S4 handrail 1000 mm (39.37") 40x2 mm tube (1.57"x 0.08")

Xstage extended height system

S4 Handrail 2000



Increase the safety and security of your Xstage platform stage system with our 2000 mm handrail. 40 mm diameter, 2 mm thick tubes.

Code	Weight	Description	
XS4RAI-GR1 2000	6.50 kg (14.00 lbs)	S4 handrail 2000 mm (78.74")	40x2 mm tube (1.57"x 0.08")

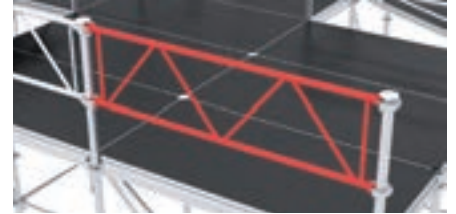

S4 Ramp



The S4 loading ramp provides easy and convenient access to your Xstage platform stage system.

Code	Weight	Description	
XS4RMP-AD1 8x2m	231.00 kg (508.00 lbs)	S4 loading ramp 8 m (26.25'), height up to 2 m (6.56')	Consists of 4x S8 modules, and includes braces and off-drive railing

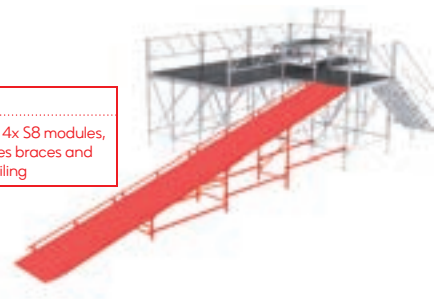

Accessories

S4 Pin



Solid aluminium pin (wedge) for connection of Xstage decks to multi-tier Xstage platform stage systems.

Code	Weight	Description	
XS4ACC-P1	0.10 kg (0.25 lbs)	S4 pin (wedge)	Connecting element



S4 Leg-Cap



Guard rail cap that completely covers the ends of handrails for increased safety of your Xstage platform stage system.

Code	Weight	Description
XS4LEG-CAP	0.10 kg (0.20 lbs)	S4 handrail leg cap



Xstage extended height system

S4 C Inner



Inner connector for safely and securely connecting two Xstage platform stage modules together through the inner girder.

Code	Weight	Description	
XS4CON-I1	0.30 kg (0.70 lbs)	S4 inner connector	For connecting two stage modules together

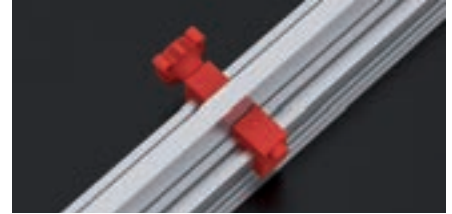

S4 C Outer



Outer connector for the safe and secure connection of your Xstage platforms to the outer girder.

Code	Weight	Description	
XS4CON-O1	0.20 kg (0.50 lbs)	S4 outer connector	For connecting two stage modules together



S4 Leg-Cover



A handrail leg cap that completely covers handrail legs for increased safety of your Xstage platform stage system.

Code	Weight	Description
XS4LEG-C1	0.45 kg (1.00 lbs)	S4 handrail leg cap



S4 Leg-Key



A key for the convenient tightening of leg caps on your Xstage platform stage system.

Code	Weight	Description
XS4LEG-K1	0.10 kg (0.20 lbs)	S4 key for tightening leg caps



Xstage extended height system

S4 Leg- Tool

Leg mounting tool for the convenient mounting and quick demounting of legs on your Xstage platform stage system.



Code	Weight	Description
XS4LEG-TL1	8.00 kg (18.00 lbs)	40x2 mm tube (1.57"x 0.08")



Xstage

**Spindlerova 286
413 01 Roudnice nad Labem
Czech Republic**

**T +420 416 810 800
info@xstage-systems.com**



www.xstage-systems.com